

Date

Name & Address

Phone

Email

TO ORDER *Fill in the frame dimentions and features requirements for variations.*

Wheel Size **24"** **25"** **26"**

Seat **Canvas** **Torsion Seat**

A. Seat Width Between Arms

B. Clearance Between Guard and Wheel

C. Leg Clearance

D. Wheel Camber

E. Footrest Height from Floor

Delivery Details

Frame S/Number

F. Seat to Floor (Front)

G. Seat to Floor (Rear)

H. Backrest Height from Frame

I. Seat Length (Cushion)

J. Frame Length from Axle





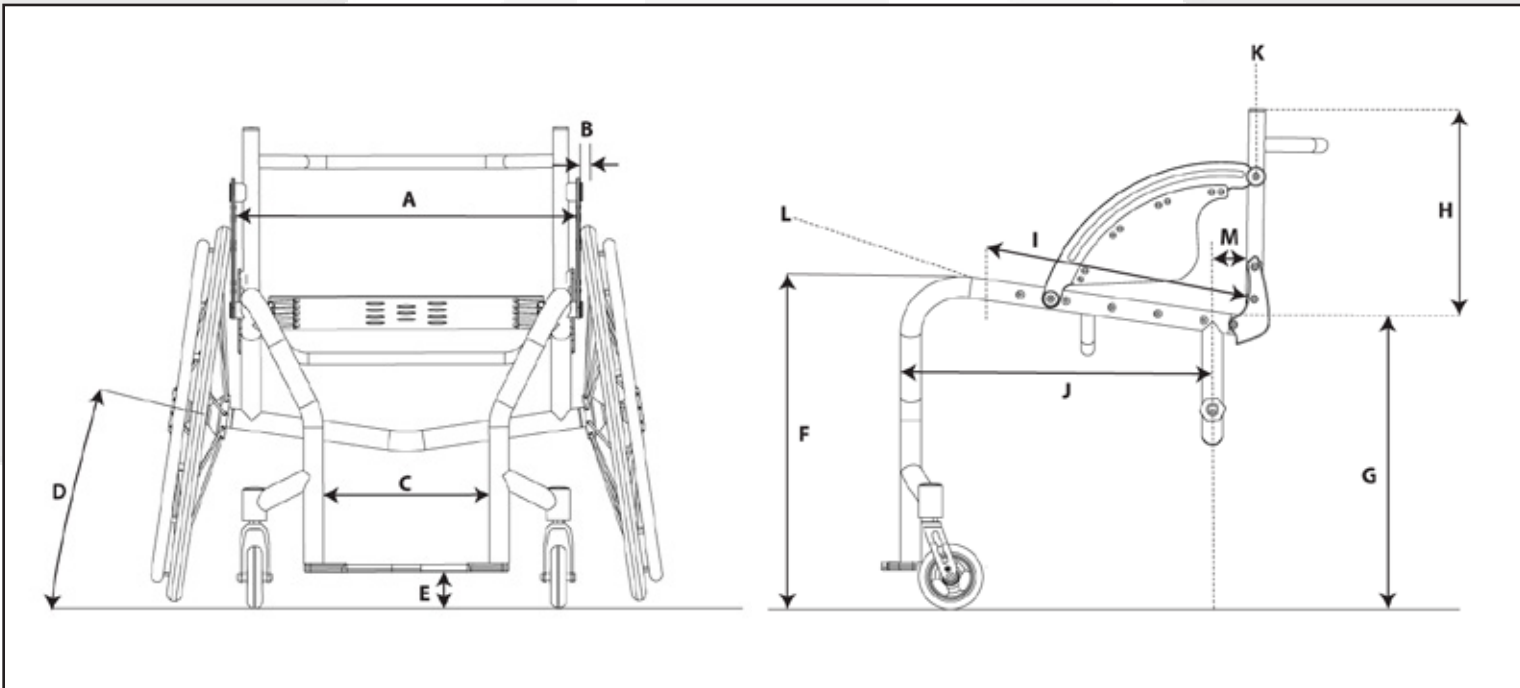

K. Backrest Angle

L. Seat Camber

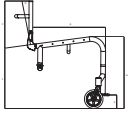
M. Axle Position from Backrest

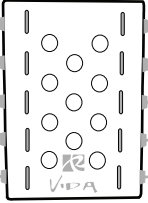
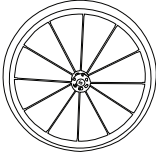
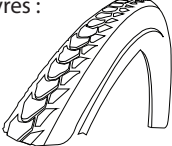
Customer Notes or Requests

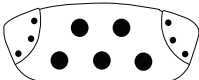
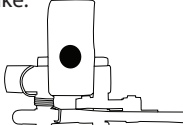

Frame: 	Fixed Backrest V001 <input type="checkbox"/> STD Folding Backrest V002 <input type="checkbox"/> STD																	
Backrest: 	Canvas V003 <input type="checkbox"/> STD Axxis Small V004 <input type="checkbox"/> £300		Axxis Medium V005 <input type="checkbox"/> £325 Axxis High V006 <input type="checkbox"/> £350															
Seat: 	Canvas Option V007 <input type="checkbox"/> STD Torsion Seat Plate V008 <input type="checkbox"/> £80		Upholstery: Fabric V009 <input type="checkbox"/> STD Vinyl V010 <input type="checkbox"/> STD Leather Standard V011 <input type="checkbox"/> £120 Leather Deluxe V012 <input type="checkbox"/> £140															
Rear Wheels: 	Spinergy 24" SPOX Red Spokes V013 <input type="checkbox"/> STD White Spokes V014 <input type="checkbox"/> STD Black Spokes V015 <input type="checkbox"/> STD Blue Spokes V016 <input type="checkbox"/> STD		Spinergy 24" LX Red Spokes V017 <input type="checkbox"/> £40 White Spokes V018 <input type="checkbox"/> £40 Black Spokes V019 <input type="checkbox"/> £40 Orange Spokes V020 <input type="checkbox"/> £40															
Tyres : 	Right Run V021 <input type="checkbox"/> STD Kenda V022 <input type="checkbox"/> STD		Special Requirements <input type="text"/> <input type="checkbox"/> £															
Wheel Castor STD: 	4" (100mm) Castor V023 <input type="checkbox"/> STD 5" (125mm) Castor V024 <input type="checkbox"/> STD 6" (150mm) Castor V025 <input type="checkbox"/> STD		Wheel Castor Frogs Legs:  4" (100mm) Frogs Legs V048 <input type="checkbox"/> £250 5" (125mm) Frogs Legs V049 <input type="checkbox"/> £260 6" (150mm) Frogs Legs V050 <input type="checkbox"/> £270															
Footrest: 	Fixed (250mm wide) V028 <input type="checkbox"/> STD Fixed (300mm wide) V029 <input type="checkbox"/> STD		Brake:  Active / Scissor Brake V030 <input type="checkbox"/> STD Push To Lock V031 <input type="checkbox"/> STD															
Colours: 	<table border="0"> <tr> <td><input type="checkbox"/> Matt Black V032</td> <td><input type="checkbox"/> Dark Blue V035</td> <td><input type="checkbox"/> Dark Red V038</td> <td><input type="checkbox"/> Pink V041</td> <td><input type="checkbox"/> White V044</td> </tr> <tr> <td><input type="checkbox"/> Gloss Black V033</td> <td><input type="checkbox"/> Mid Blue V036</td> <td><input type="checkbox"/> Light Red V039</td> <td><input type="checkbox"/> Matt Cream V042</td> <td><input type="checkbox"/> Silver V045</td> </tr> <tr> <td><input type="checkbox"/> Graphite V034</td> <td><input type="checkbox"/> Light Blue V037</td> <td><input type="checkbox"/> Orange V040</td> <td><input type="checkbox"/> Gloss Cream V043</td> <td><input type="checkbox"/> Chrome V046</td> </tr> </table>			<input type="checkbox"/> Matt Black V032	<input type="checkbox"/> Dark Blue V035	<input type="checkbox"/> Dark Red V038	<input type="checkbox"/> Pink V041	<input type="checkbox"/> White V044	<input type="checkbox"/> Gloss Black V033	<input type="checkbox"/> Mid Blue V036	<input type="checkbox"/> Light Red V039	<input type="checkbox"/> Matt Cream V042	<input type="checkbox"/> Silver V045	<input type="checkbox"/> Graphite V034	<input type="checkbox"/> Light Blue V037	<input type="checkbox"/> Orange V040	<input type="checkbox"/> Gloss Cream V043	<input type="checkbox"/> Chrome V046
<input type="checkbox"/> Matt Black V032	<input type="checkbox"/> Dark Blue V035	<input type="checkbox"/> Dark Red V038	<input type="checkbox"/> Pink V041	<input type="checkbox"/> White V044														
<input type="checkbox"/> Gloss Black V033	<input type="checkbox"/> Mid Blue V036	<input type="checkbox"/> Light Red V039	<input type="checkbox"/> Matt Cream V042	<input type="checkbox"/> Silver V045														
<input type="checkbox"/> Graphite V034	<input type="checkbox"/> Light Blue V037	<input type="checkbox"/> Orange V040	<input type="checkbox"/> Gloss Cream V043	<input type="checkbox"/> Chrome V046														
Notes:																		